

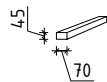

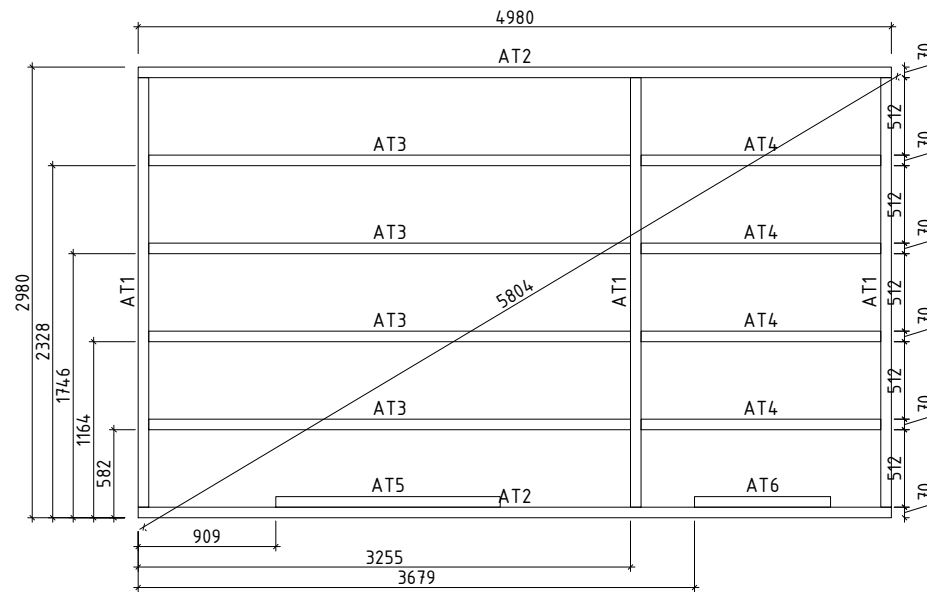







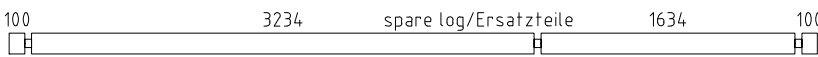



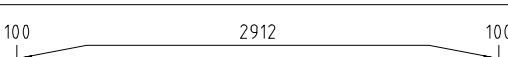

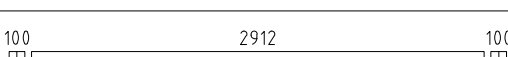
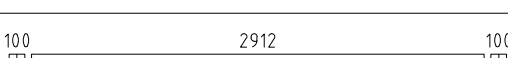

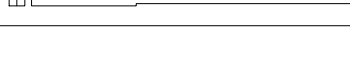
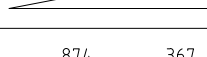
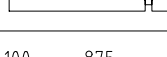
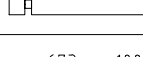

Name	Super Fred 320x520 44		SKU	G0173	
Drawing/Zeichnung	Plan/Grundplan		Format	A4	
Profile/Profil	4.4x13.5	Scale/Maßstab	1:30	Date	30.03.2023



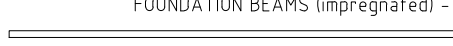

 <a href="http://www.hansa24.com">www.hansa24.com</a>	Name Super Fred 320x520 44		SKU G0173
	Drawing/Zeichnung Foundation plan_Lagerholzplan		Format A4
	Profile/Profil 4.4x13.5	Scale/Maßstab 1:50	Date 30.03.2023

Pos	Model Super Fred 320x520 44	Pcs	Profile (mm)	Length (mm)
	Notice! The gable pieces can be partly pre-assembled! Please notice - those differ from the description given in the specification list.			
	Achtung! Die Giebelbohlen können teilweise schon vormontiert sein! Bitte beachten - diese erscheinen nicht ganz so wie in der Teilleiste beschrieben.			
003		1	44x135	5200
001		1	44x135	5600
002		1	44x135	5600
003		15	44x135	5200
004		2	44x135	3200
005		1	44x135	3200
006		20	44x135	3200
007		2	44x68	3200
008		15	44x135	3200
009		1	44x68	3200
010		1	44x135	3200
011		3	44x135	2204
012		15	44x135	1285
013		15	44x135	1019
014		18	44x135	817
015		15	44x135	511
016		6	44x68	364
AT2	FOUNDATION BEAMS (impregnated) - FUNDAMENTHÖLZER (imprägniert) 	2	70x45	4980
AT3	FOUNDATION BEAMS (impregnated) - FUNDAMENTHÖLZER (imprägniert) 	4	70x45	3185
AT1	FOUNDATION BEAMS (impregnated) - FUNDAMENTHÖLZER (imprägniert) 	3	70x45	2840
AT4	FOUNDATION BEAMS (impregnated) - FUNDAMENTHÖLZER (imprägniert) 	4	70x45	1585
AT5	FOUNDATION BEAMS (impregnated) - FUNDAMENTHÖLZER (imprägniert) 	1	70x45	1485
AT6	FOUNDATION BEAMS (impregnated) - FUNDAMENTHÖLZER (imprägniert) 	1	70x45	900
Kood	Super Fred 320x520 44	Materjal	File	Leht 1/6

Pos	Model Super Fred 320x520 44	Pcs	Profile (mm)	Length (mm)
PR1		3	70x145	5600
	ROOF BOARDS - DACHBRETTER	50+2	113x18	1934
	ROOF BOARDS - DACHBRETTER	50	113x18	1782
	FLOOR BOARDS - FUSSBODENBRETTER	44+1	113x18	2907
	Ceiling mouldings - Deckenleisten (inside and outside - innen und außen)		15x28	48 cm/lfm
	Floor mouldings - Fussbodenleisten		18x40	23 cm/lfm
RLA 01-1	Eave board - Traufenbrett 18x95	2	18x95	5600
RLI01-1	Eave slat - Traufenleiste 18x40		18x40	12.2 cm/lfm
VLA 02-1	Gable board - Giebelbrett 18x120 10.8°	2	18x120	1882
VLA 02-2	Gable board - Giebelbrett 18x120 10.8°	2	18x120	2034
VKL 02-1	Gable cover slat - Giebeldeckleiste 18x58	2	18x58	1882
VKL 02-2	Gable cover slat - Giebeldeckleiste 18x58	2	18x58	2034
GD01	Diamond - Diamant	2		
LK	Hit block - Schlaghölzer	3		
N-0 2503	Nails - Nägel 2.5x60 for floor boards - für Fussbodenbretter	528		
N-0 2501	Nails - Nägel vierkant 2.5x50 for ceiling boards - für Dachbretter	600		
KR-0 3001	Screws - Schrauben 3.0x30 for ceiling mouldings - für Deckenleisten	76		
KR-0 3002	Screws - Schrauben 3.0x30 for eave slats - für Traufenleisten	24		
KR-0 3003	Screws - Schrauben 3.0x30 for floor mouldings - für Fussbodenleisten	44		
KR-0 3523	Screws - Schrauben 3.5x45 C3 for diamonds - für Diamanten	4		
KR-0 3525	Screws - Schrauben 3.5x45 C3 for eave boards - für Traufenbretter	24		
KR-0 3527	Screws - Schrauben 3.5x45 C3 for gable boards - für Giebelbretter	16		
KR-0 3521	Screws - Schrauben 3.5x45 C3 for gable cover slats - für Giebeldeckleisten	16		
KR-0 5080	Screws - Schrauben 5.0x100 for foundation beams - für Fundamenthölzer	60		
KL1	Threaded rod - Gewindestange M8	4		2000
Kood	Super Fred 320x520 44	Materjal	File	Leht 2/6











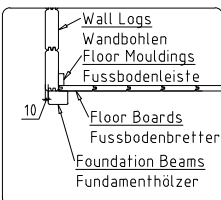
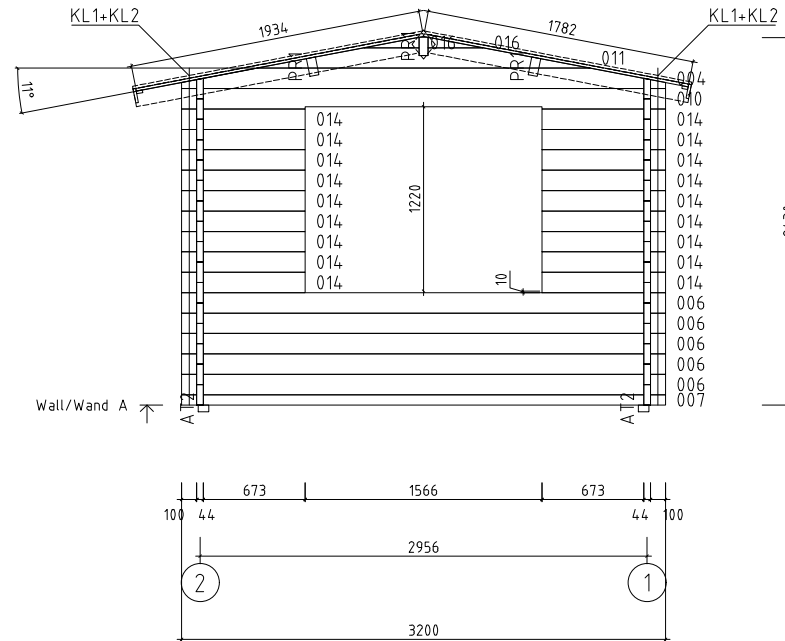
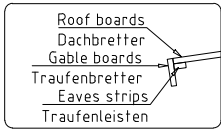





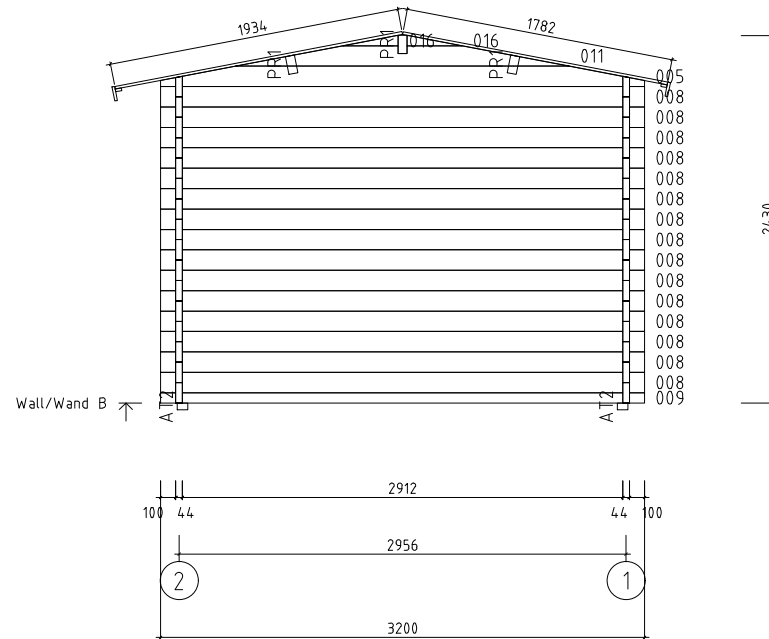

 www.hansa24.com	Name Super Fred 320x520 44		SKU G0173
	Drawing/Zeichnung Wall/Wand A		Format A4
	Profile/Profil 4.4x13.5	Scale/Maßstab 1:50	Date 29.06.2023

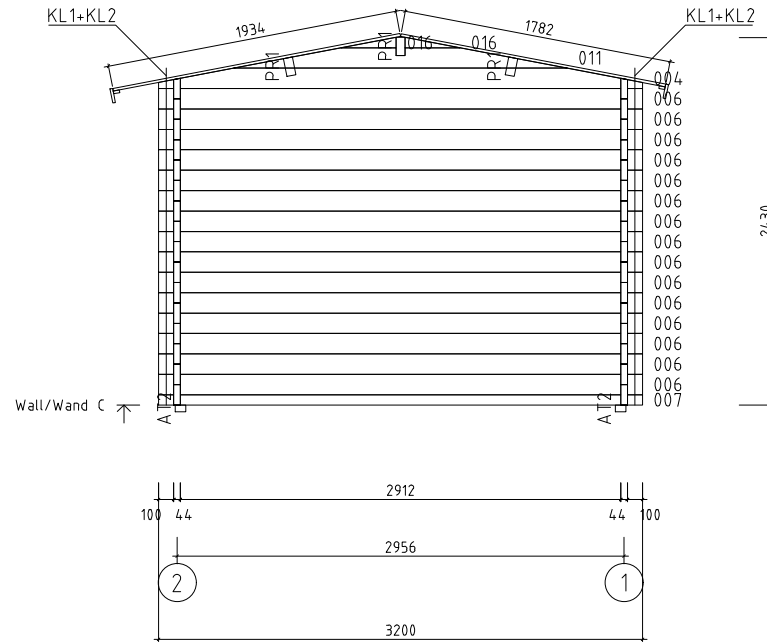

 www.hansa24.com	Name Super Fred 320x520 44		SKU G0173
	Drawing/Zeichnung Wall/Wand B		Format A4
	Profile/Profil 4.4x13.5	Scale/Maßstab 1:50	Date 29.06.2023



 <a href="http://www.hansa24.com">www.hansa24.com</a>	Name		Super Fred 320x520 44		SKU		G0173	
	Drawing/Zeichnung		Wall/Wand C			Format		A4
	Profile/Profil	4.4x13.5	Scale/Maßstab	1:50	Date	29.06.2023		

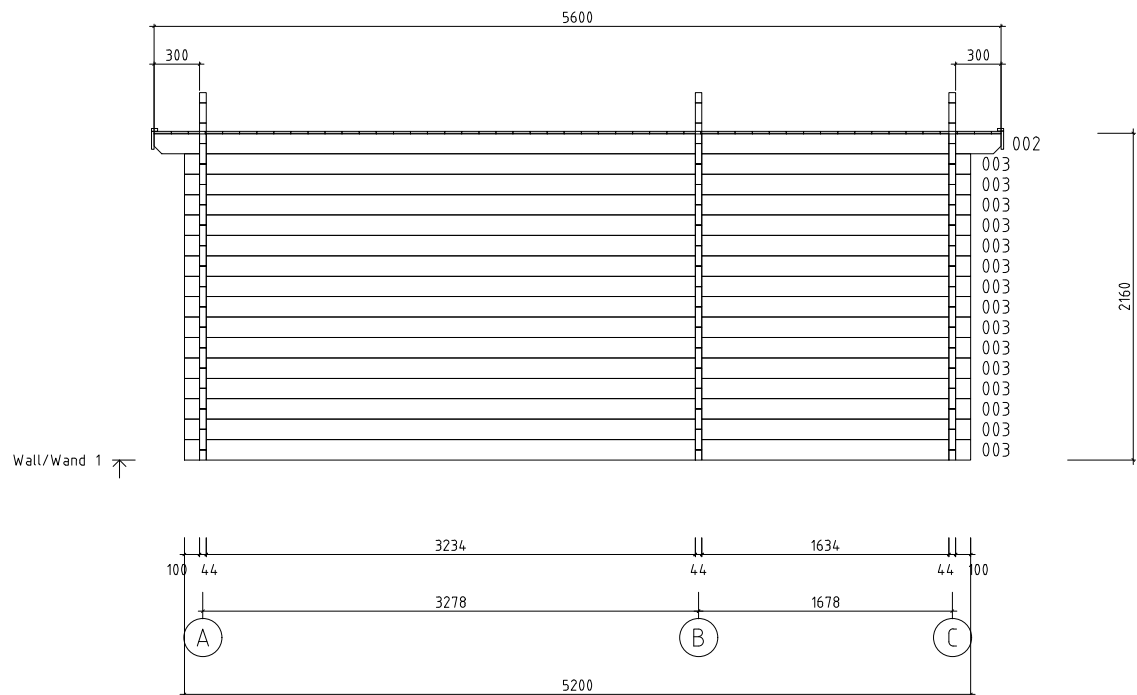
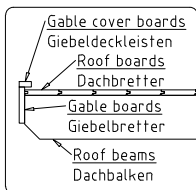

 www.hansa24.com	Name Super Fred 320x520 44		SKU G0173
	Drawing/Zeichnung Wall/Wand 1		Format A4
	Profile/Profil 4.4x13.5	Scale/Maßstab 1:50	Date 29.06.2023

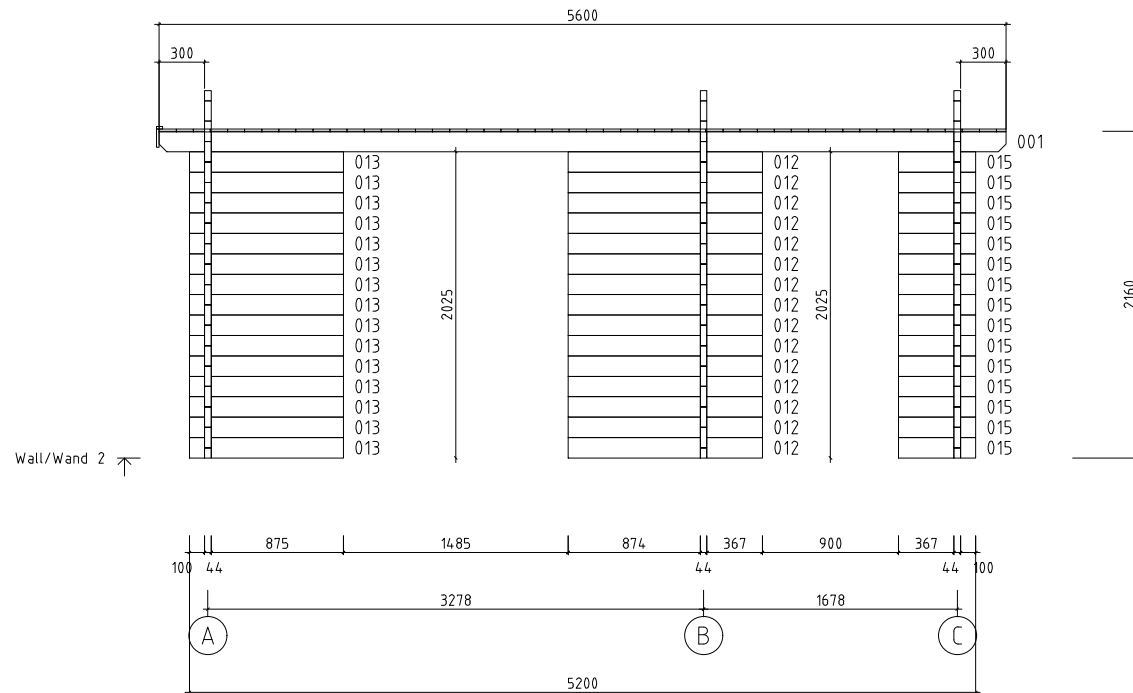

 <a href="http://www.hansa24.com">www.hansa24.com</a>	Name Super Fred 320x520 44		SKU G0173
	Drawing/Zeichnung Wall/Wand 2		Format A4
	Profile/Profil 4.4x13.5	Scale/Maßstab 1:50	Date 29.06.2023